

ISTRUZIONI DI MONTAGGIO
FITTING INSTRUCTIONS
INSTRUCTIONS DE MONTAGE
MONTAGEANLEITUNG
INSTRUCCIONES DE MONTAJE
ИНСТРУКЦИЯ ПО УСТАНОВКЕ



DISPOSITIVO DI TRAINO TIPO TOWING DISPOSAL TYPE TYPE DU DISPOSITIF DE REMORQUAGE ANHÄNGERVORRICHTUNG TYP DISPOSITIVO DE CAREO TIPO ТЯГОВО-ЦЕПНОЕ УСТРОЙСТВО	39026						
PER AUTOVEICOLI FOR CARS POUR VÉHICULES AUTOMOBILES FÜR KRAFTFAHRZEUGE PARA AUTOVEHICULO ДЛЯ АВТОМОБИЛЕЙ	TOYOTA AVENSIS SW '03 2003 -2008 (T25)						
CLASSE E TIPO DI ATTACCO CLASS AND HITCH TYPE CLASSE ET TYPE DE CROCHET KLASSE UND BEFESTIGUNGSART CLASES DE ACOPLAMIENTO КЛАСС И ТИП СОЕДИНЕНИЯ	F						
OMOLOGAZIONE HOMOLOGATION HOMOLOGATION ZULASSUNG APROBACION ОМОЛОГАЦИЯ	e3 00 – 7266 (DIR. 94/20/CE)						
CARICO VERTICALE MAX S VALUE MASSE VERTICALE MAXIMUM ZUL. STUETZLAST CARGA MAX. VERTICAL МАКСИМАЛЬНАЯ ВЕРИКАЛЬНАЯ НАГРУЗКА	S = kg 80						
VALORE D D VALUE VALEUR D D WERT VALOR D ЗНАЧЕНИЕ	$D = \frac{\begin{matrix} \text{Max } \downarrow \text{ Kg} \\ \text{---} \times \text{---} \\ \text{Max } \downarrow \text{ Kg} \end{matrix} + \begin{matrix} \text{Max } \downarrow \text{ Kg} \\ \text{---} \\ \text{Max } \downarrow \text{ Kg} \end{matrix}}{\begin{matrix} \text{Max } \downarrow \text{ Kg} \\ \text{---} \\ \text{Max } \downarrow \text{ Kg} \end{matrix}} \times 0,00981 \leq 8,7 \text{ kN}$						
COPPIA DI SERRAGGIO PER VITI (8.8): TORQUE SETTINGS FOR NUTS AND BOLTS (8.8): COUPLE DE SERRAGE POUR VIS (8.8): SCHRAUBENZUGSMOMENT (8.8): MOM. DE PRESION PARA TORNILLOS Y TUERCAS (8.8): СПИСОК ДЕТАЛЕЙ (8.8):	<table> <tr> <td>M6 = 10 Nm</td> <td>M8 = 25 Nm</td> </tr> <tr> <td>M10 = 55 Nm</td> <td>M12 = 85 Nm</td> </tr> <tr> <td>M14 = 135 Nm</td> <td>M16 = 200 Nm</td> </tr> </table>	M6 = 10 Nm	M8 = 25 Nm	M10 = 55 Nm	M12 = 85 Nm	M14 = 135 Nm	M16 = 200 Nm
M6 = 10 Nm	M8 = 25 Nm						
M10 = 55 Nm	M12 = 85 Nm						
M14 = 135 Nm	M16 = 200 Nm						

WICHTIGE MERKMALE

- ◆ Sich vor der ersten Installation versichern dass die Anhängervorrichtung für das Fahrzeug geeignet ist an dem sie installiert werden soll. Insbesondere überprüfen ob, die Zulassungsnummer des Kraftfahrzeugscheines oder der Fahrzeugstyp dem in den Papieren der Anhängerkupplung entspricht. Im gegenteiligen Fall, das zuständige Büro (umbrarimorchi@umbrarimorchi.it) kontaktieren, für Erklärungen oder die aktuellste Version der Papiere;
- ◆ Die Anhängervorrichtung ist ein Sicherheitsteil und darf nur von Fachpersonal montiert werden;
- ◆ Beschädigte oder abgenützte Elemente dürfen nur von Fachpersonal und mit originalen Ersatzteilen ersetzt werden;
- ◆ Jegliche wesentliche Änderungen oder Reparaturen an der Anhängervorrichtung sind verboten.

GEBRAUCHS- UND ANWENDUNGSANLEITUNGEN

- ◆ Die Kupplungskugel muss immer sauber und eingeschmiert sein. Aus Sicherheitsgründen den Kugeldurchmesser ab und zu kontrollieren: falls er in mehreren Punkten eine Breite von 49mm erreicht, darf die Anhängervorrichtung nicht mehr verwendet werden, bis die Kupplungskugel ersetzt wird;
- ◆ Nach 1000 km alle Schrauben kontrollieren und sie nach dem "Schraubenanzugsmoment" regulieren.

	39026	13/06/17 v. 1.0	P. 2 / 13
			

39026/C - 39026/F

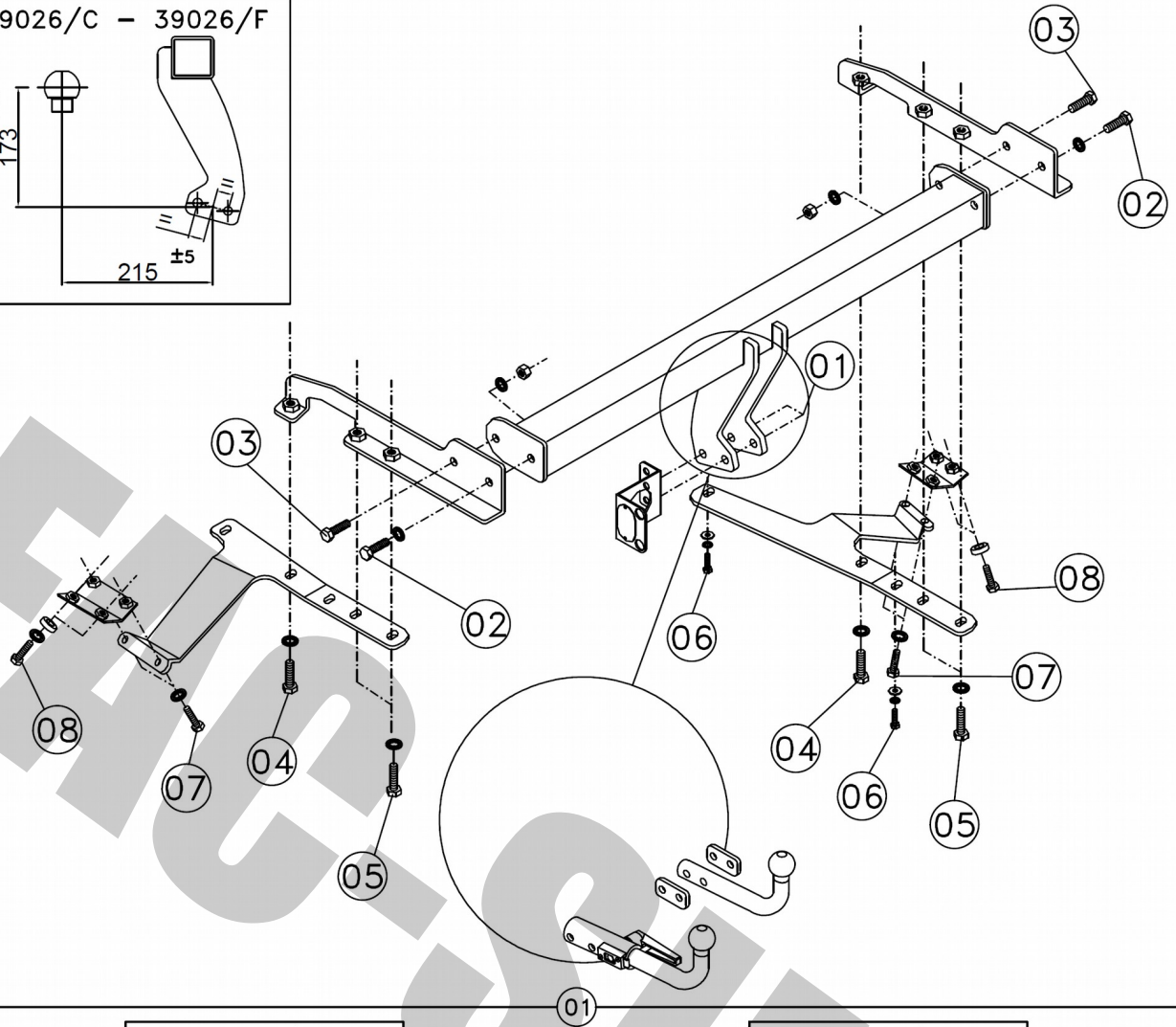
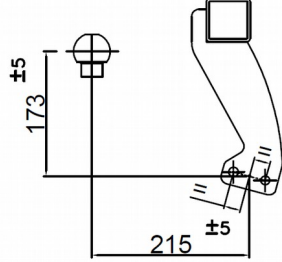

39026/F

①	2x	M12x85 (8.8)	
②	2x	M12 (8.8)	
③	2x	SPESSORI SPACERS	

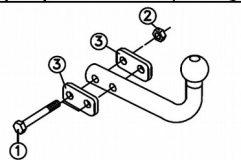

U.R. SF12/C
e3 00-7672
E57 55R-01 0003

(F21A)

39026/C

①	2x	M12x25 (8.8)	
②	2x	12.2x27x2.5	
③	1x	M12x85 (8.8)	
④	1x	M12 (8.8)	

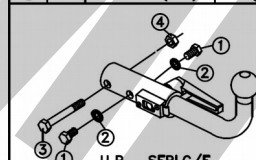

U.R. SFBLC/E
e3 00-7137
(21 AY)

②	2x		M10x30		CONTACT 10x22x1,5	
③	2x		M10x30		CONTACT 10x22x1,5	M10
④	2x		M10x35		CONTACT 10x22x1,5	
⑤	4x		M10x50		CONTACT 10x22x1,5	
⑥	2x		M6x20		CONTACT 6x14x1,2	6x18x1,5
⑦	4x		M8x25		CONTACT 8x18x1,4	
⑧	4x		M8x25		CONTACT 8x18x1,4	\varnothing 25x5 Lg. 9mm



39026

13/06/17 v. 1.0

P. 3 / 13



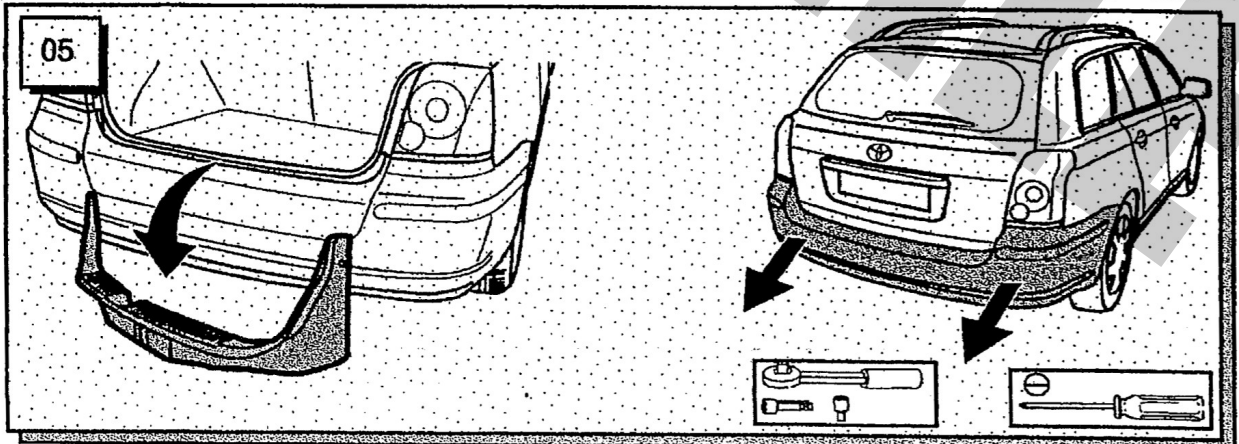
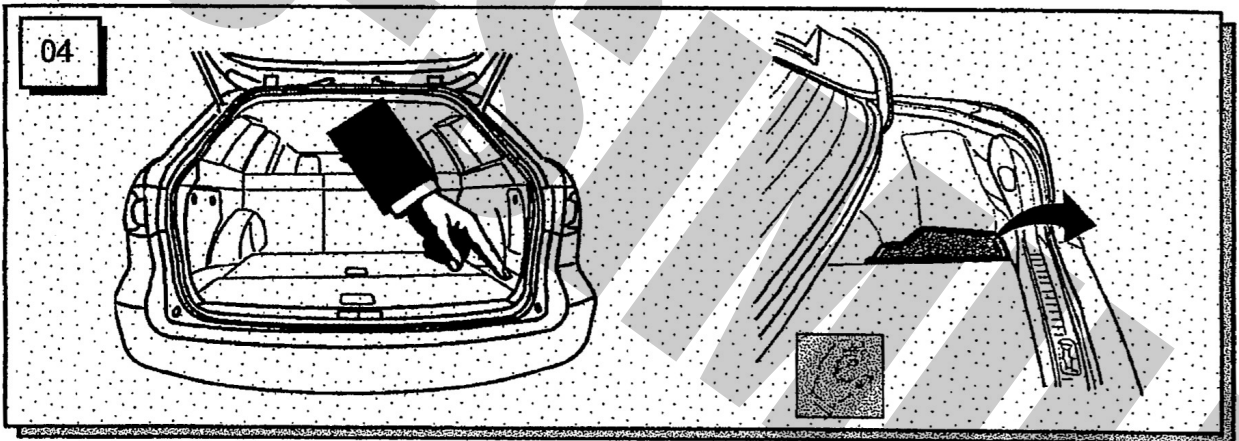
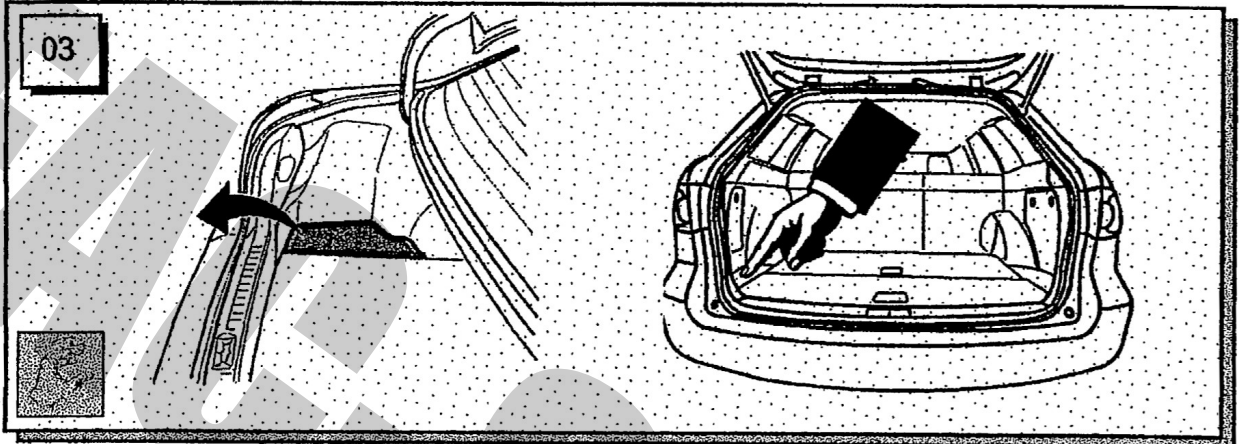
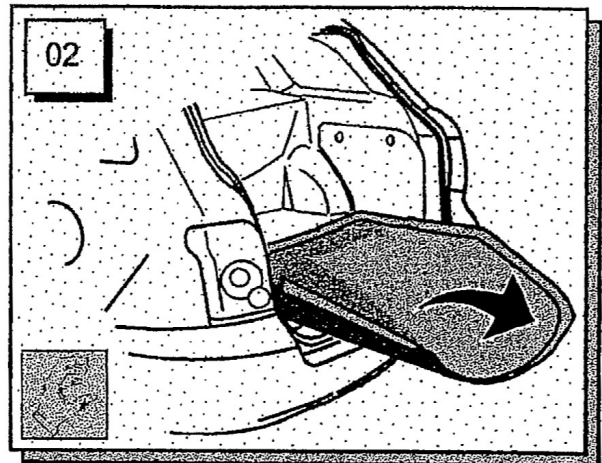
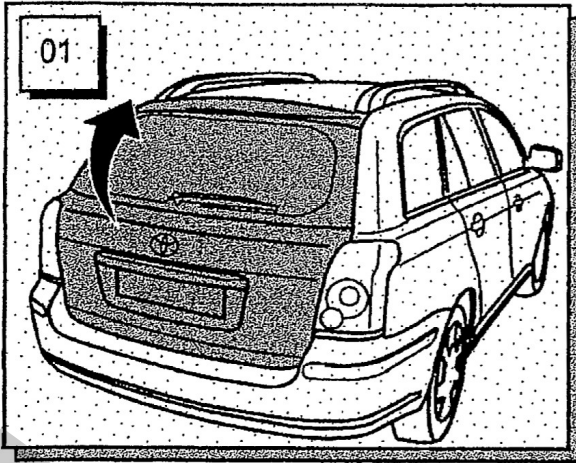

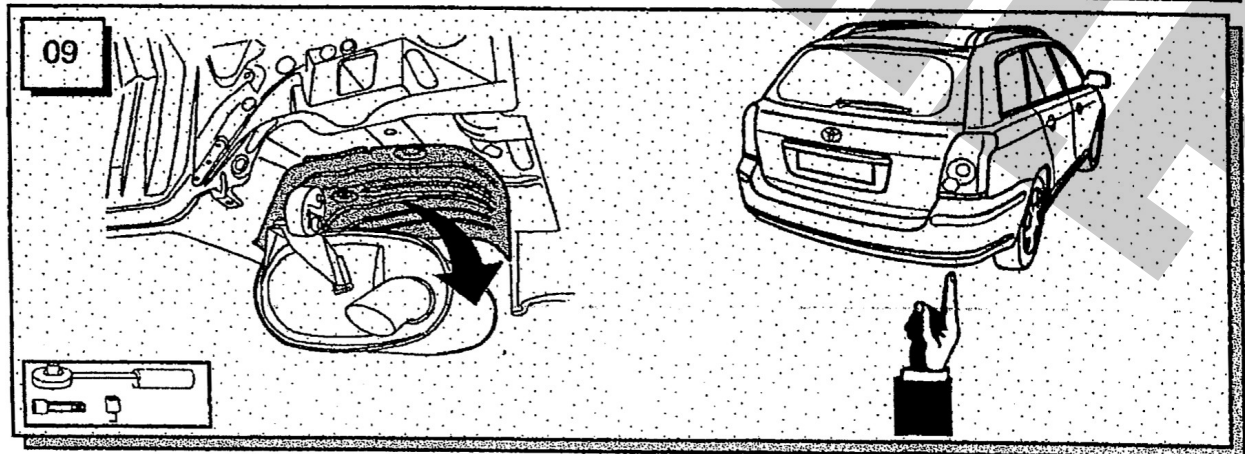
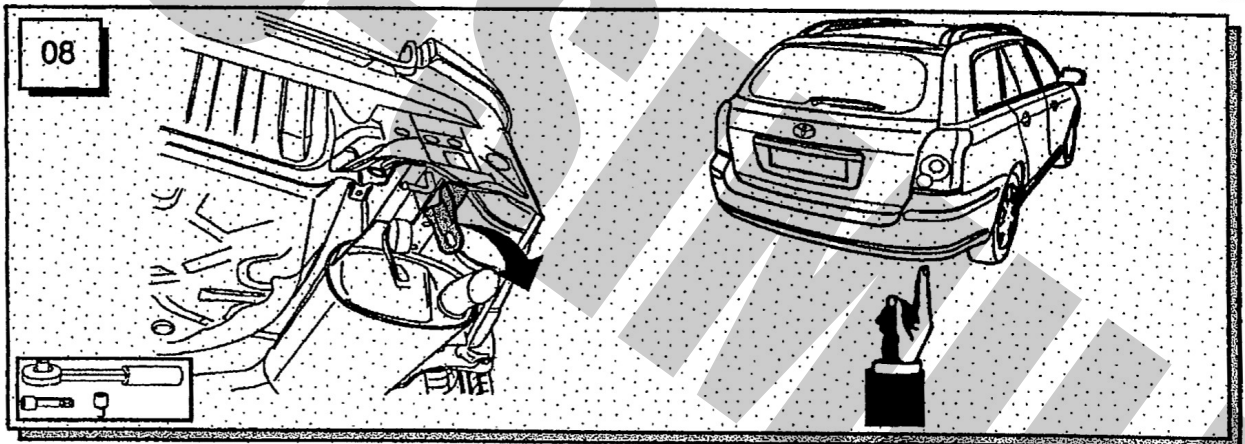
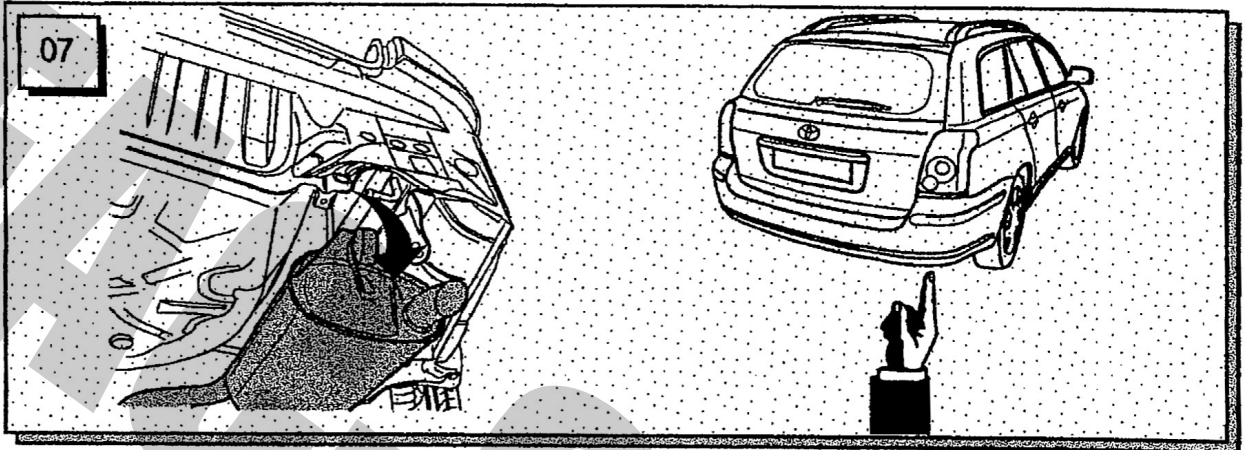
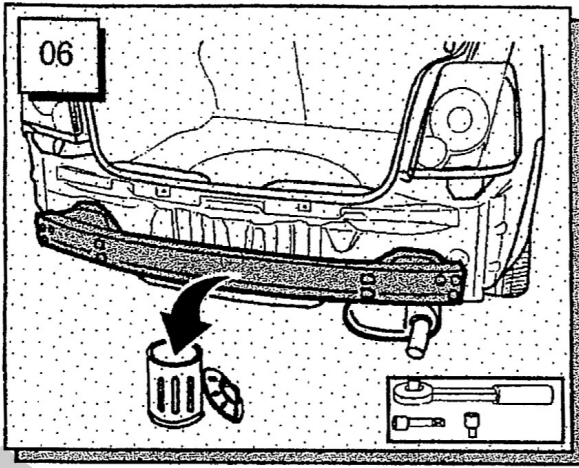

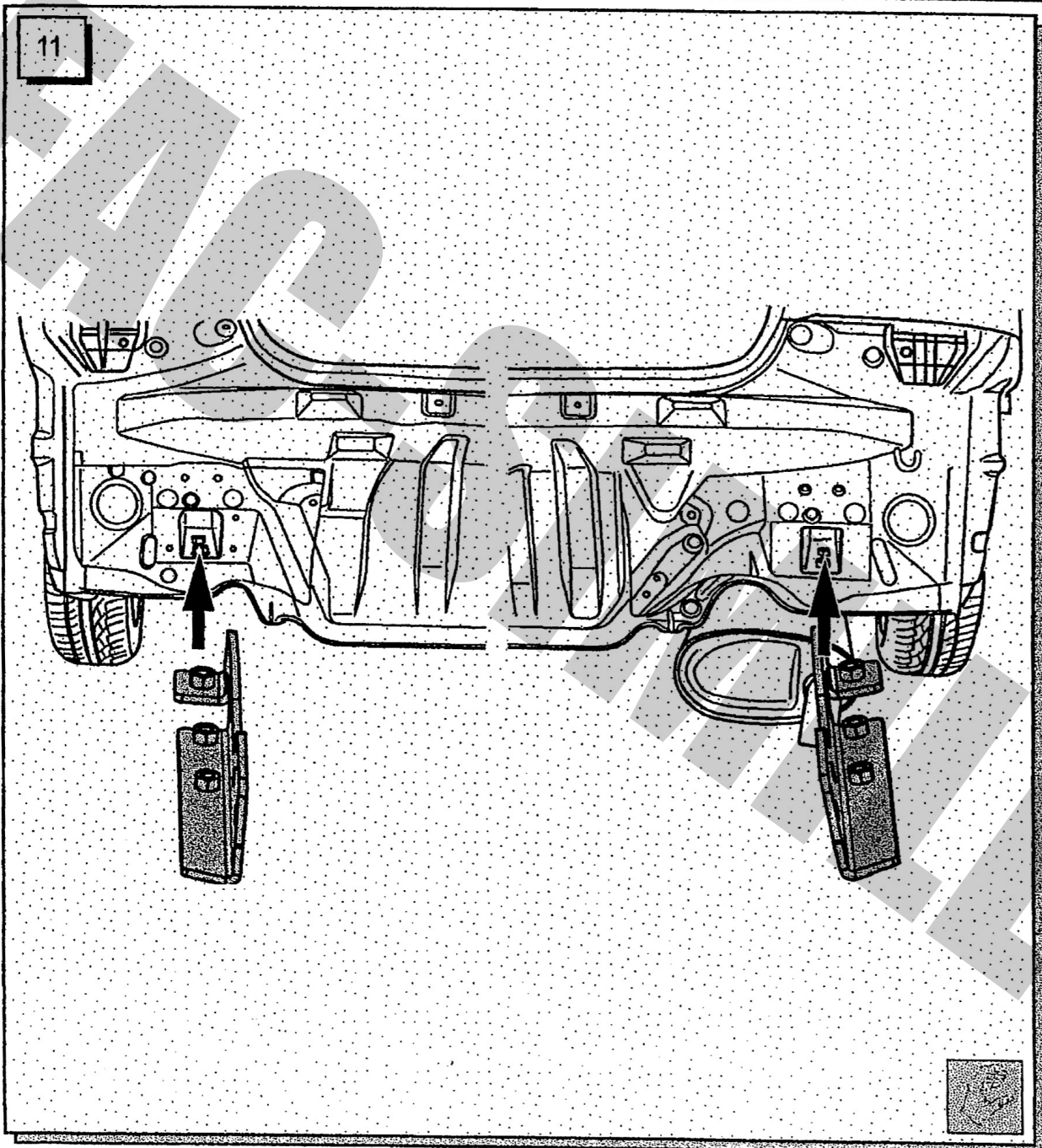
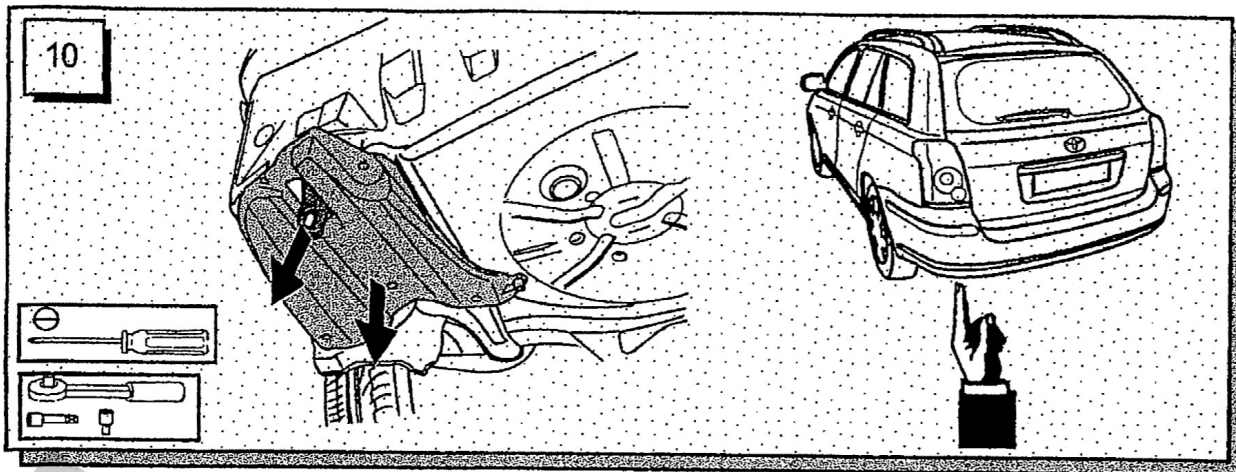

12

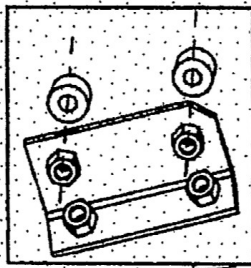

Ø25x5x9(2x)

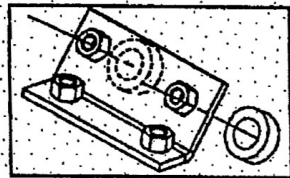
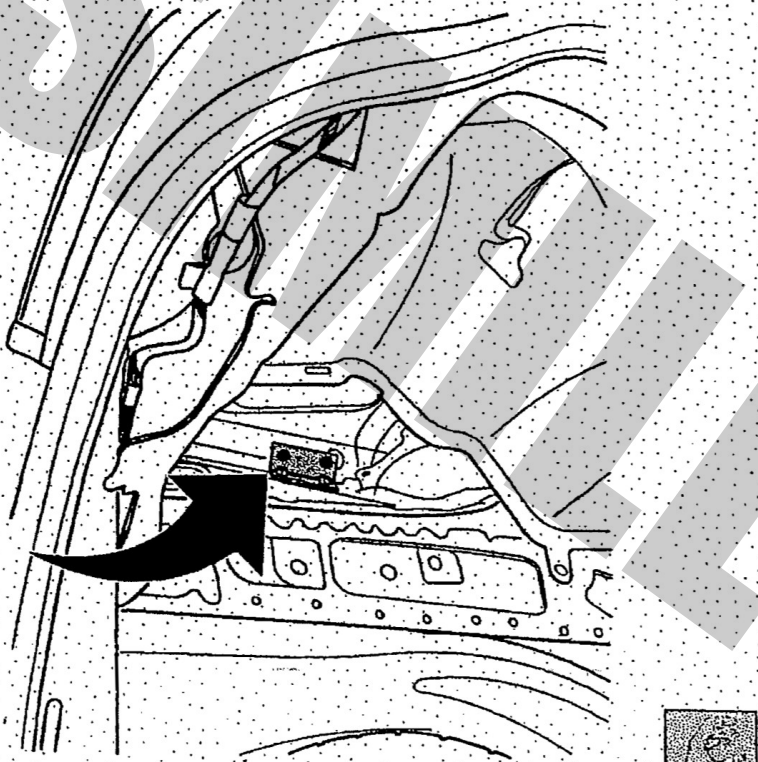
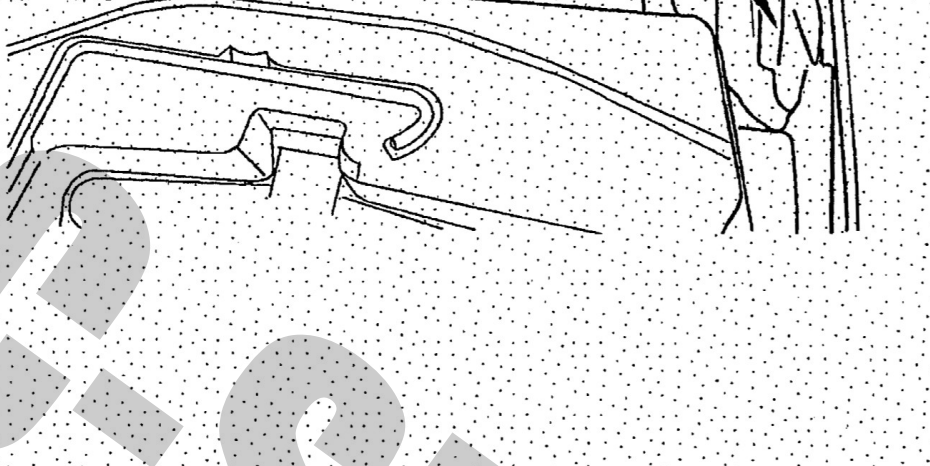
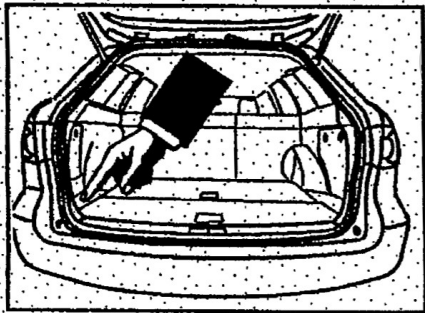
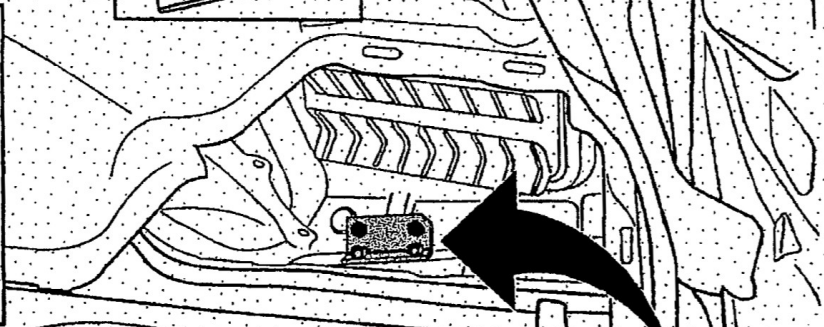
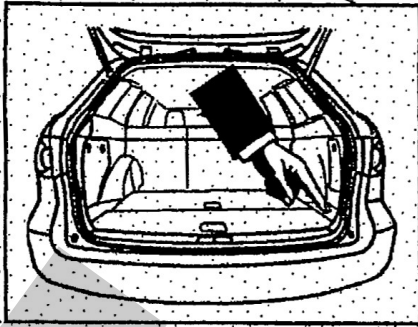

Ø25x5x9(2x)



39026

13/06/17 v. 1.0

P. 7 / 13



13

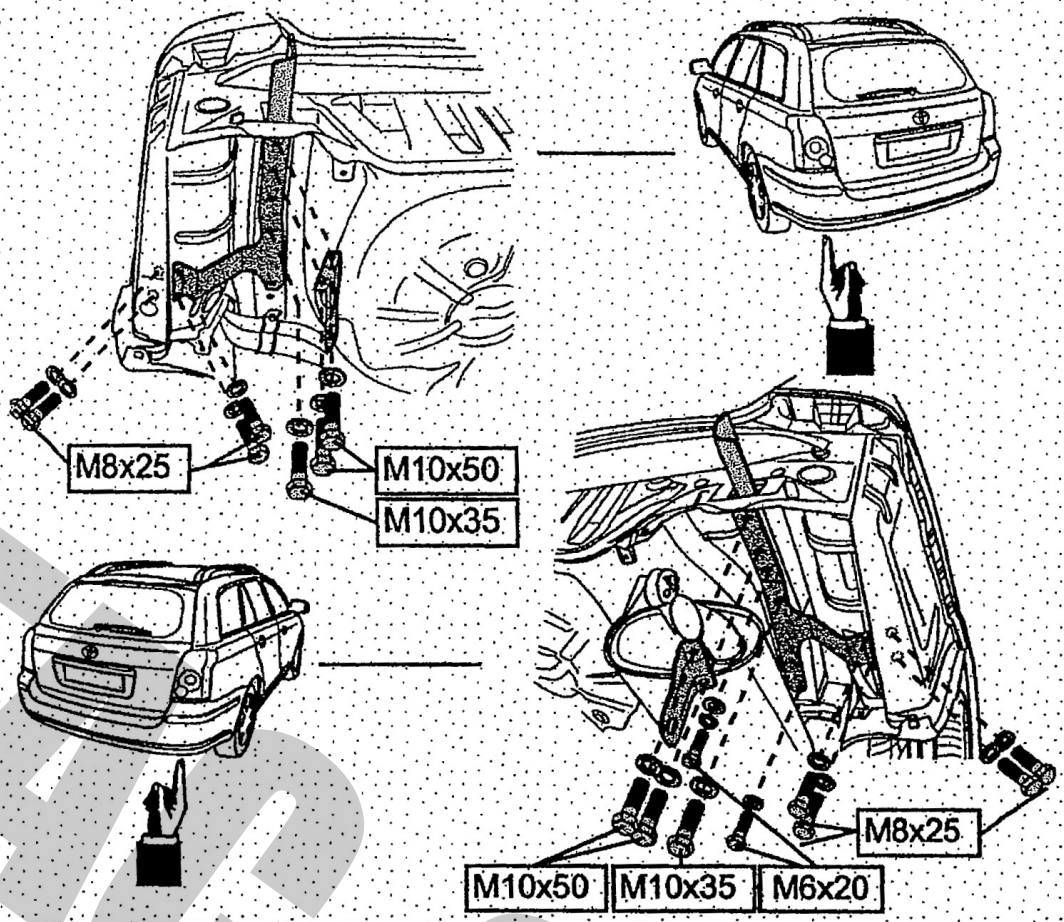

14

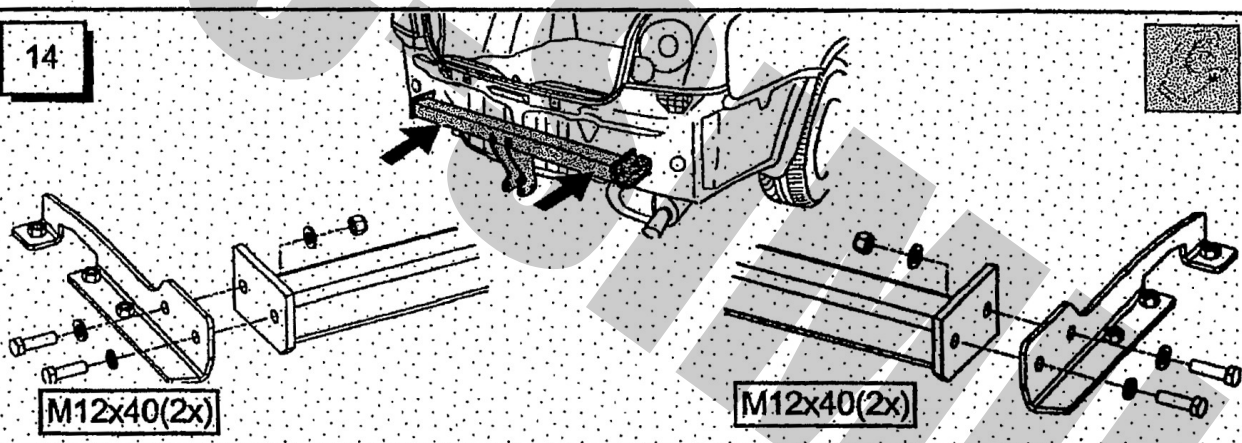

15

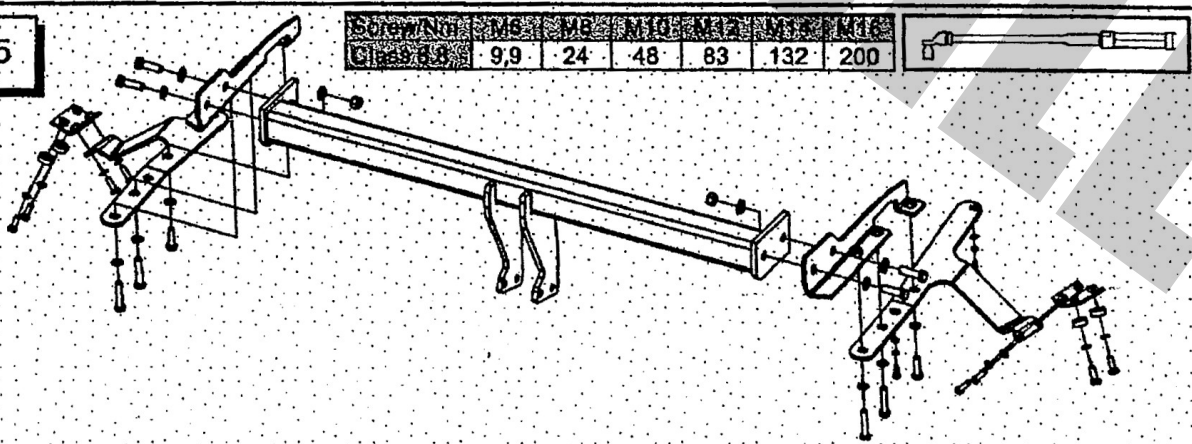

39026

13/06/17 v. 1.0

P. 8 / 13



16

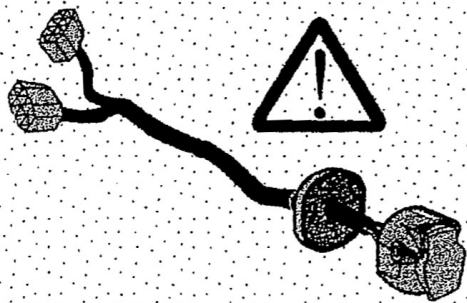

17

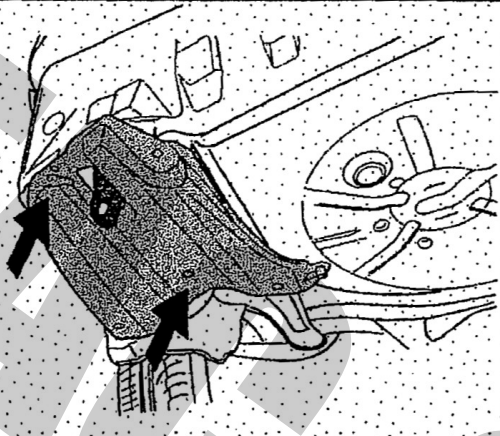

18

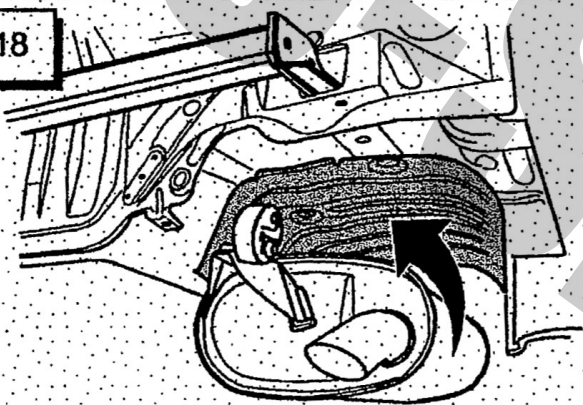

19

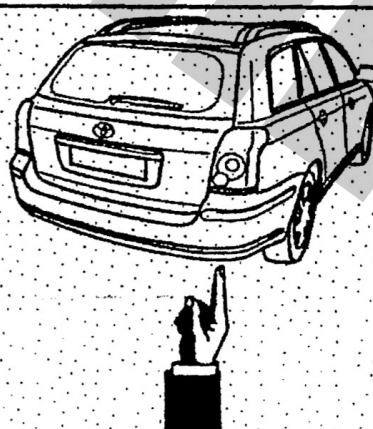
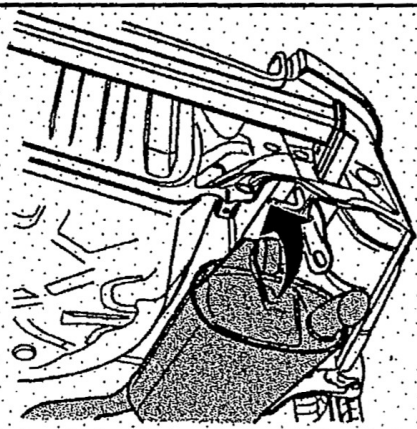

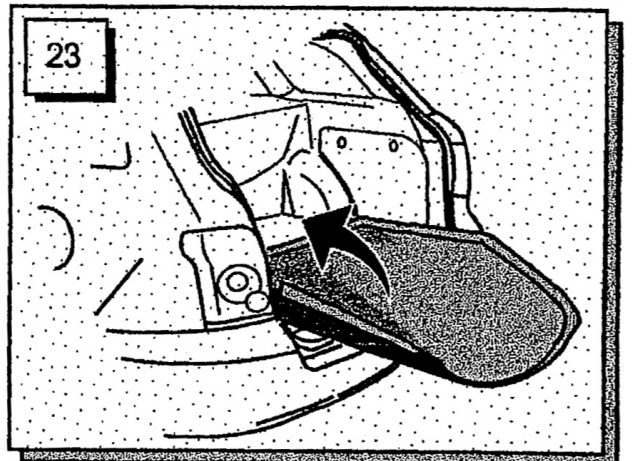
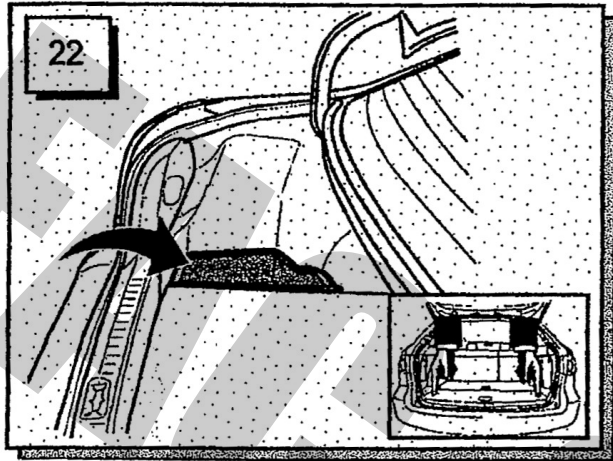
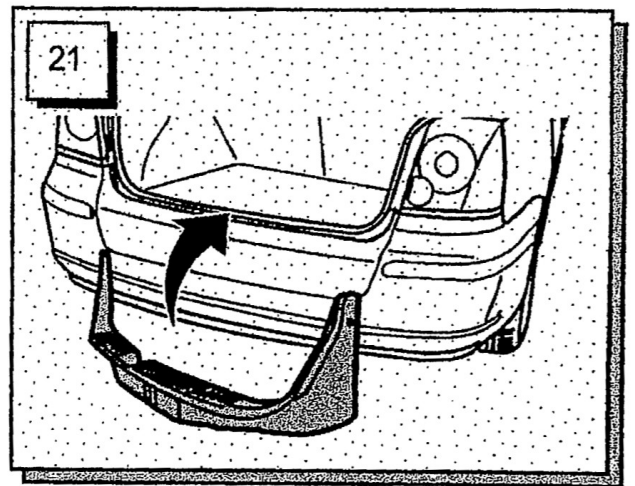
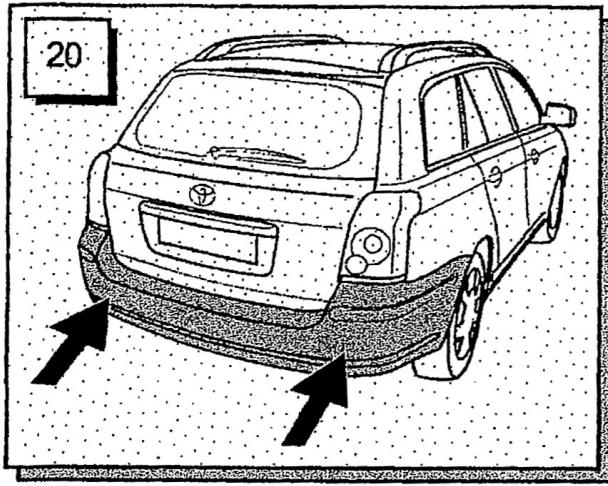

39026

13/06/17 v. 1.0

P. 10 / 13



NOTE IMPORTANTI:

1. Prima dell'installazione assicurarsi che il dispositivo di traino in oggetto sia adatto per il veicolo sul quale lo si intende installare verificando che il n° di omologazione e di estensione oppure il tipo dell'autoveicolo, riportati sulla carta di circolazione, esista sul documento del gancio traino. In caso contrario consultare l'ufficio documenti per chiarimenti o richiesta di documenti aggiornati.
2. Il dispositivo di traino è un elemento di sicurezza e come tale deve essere installato solamente da un tecnico specializzato.
3. Elementi danneggiati o usurati devono essere sostituiti con ricambi originali da un tecnico specializzato.
4. E' proibito effettuare qualsiasi tipo di modifica significativa o riparazione alla struttura del dispositivo di traino.

USO E MANUTENZIONE:

5. La sfera del dispositivo di traino deve essere mantenuta pulita e lubrificata. Per la massima sicurezza controllare saltuariamente il diametro della sfera; qualora il diametro della stessa, in diversi punti, sia ridotto a 49 mm il dispositivo di traino non potrà essere più utilizzato sino alla sostituzione della sopraccitata sfera.
6. Dopo 1000 Km di traino tutta la bulloneria del dispositivo di traino deve essere controllata e riportata al valore di coppia di serraggio come indicato nella pagina delle istruzioni di montaggio.

ATTENZIONE :

L'installatore del gancio di traino ha l'obbligo di fissare, all'altezza della sfera, in posizione ben visibile, una targhetta con l'indicazione del carico massimo sulla sfera prescritto per la vettura sulla quale viene montato il dispositivo di traino.

DISPOSITIVO DI TRAINO TIPO: 39026
TIPO FUNZIONALE: T25 ??????W ?????? ???????, T25 ??????W ?????? ?????? ??, T25 ??????W? ?????? ?????? ??
LARGHEZZA MAX RIMORCHIABILE : 2,50 m
MASSA RIMORCHIABILE : (vedere nella carta di circolazione del veicolo).



DA COMPILARE PER IL COLLAUDO

DICHIARAZIONE DI RESPONSABILITA' PER IL MONTAGGIO :

Si dichiara che il presente dispositivo di traino tipo..... è stato montato a regola d'arte, rispettando le prescrizioni fornite sia del costruttore del veicolo che del costruttore del dispositivo di traino, sull'autoveicolo modello..... con targa.....

....., li (timbro e firma)

Si dichiara inoltre di aver informato l'utente del veicolo sull'USO e MANUTENZIONE del dispositivo stesso

	39026	13/06/17 v. 1.0	P. 11 / 13
			

MECCANISMO MOD. C 2007

NL - Demontage	S - Demontering	I - Smontaggio
GB - Disounting	DK - Frakobling	
D - Demontage	FIN - Irrotta	
F - Démontage	E - Desmontaje	

NL - Montage	S - Montering	I - Montaggio
GB - Mounting	DK - Tilkobling	
D - Montage	FIN - Aseennus	
F - Montage	E - Montaje	

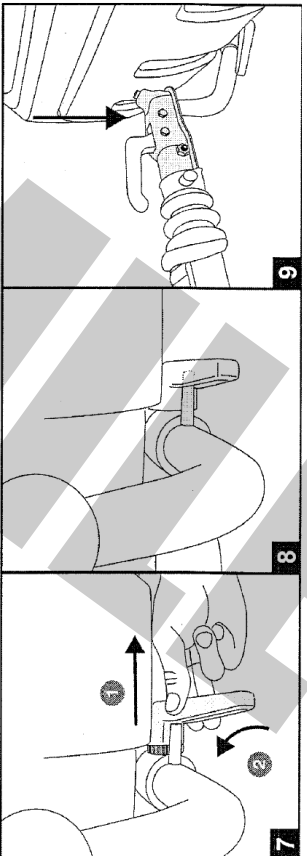
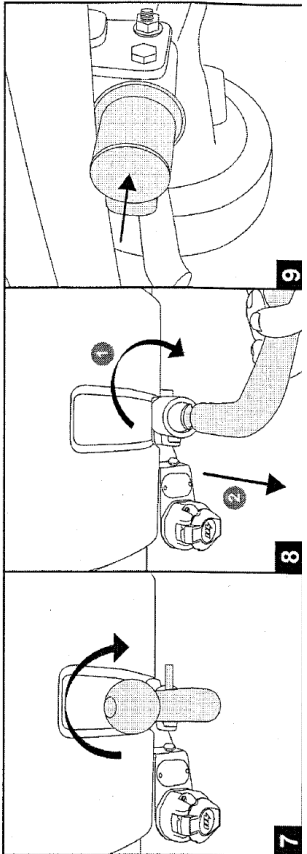
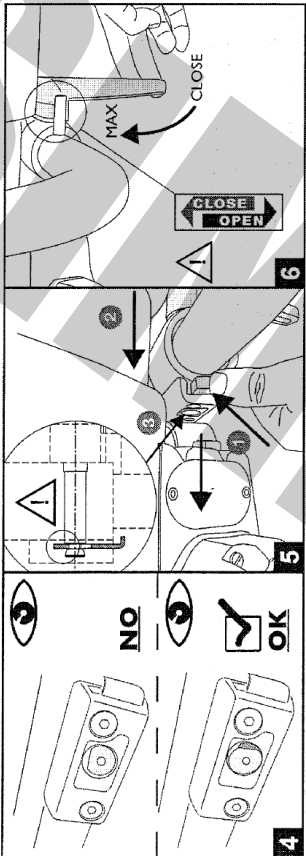
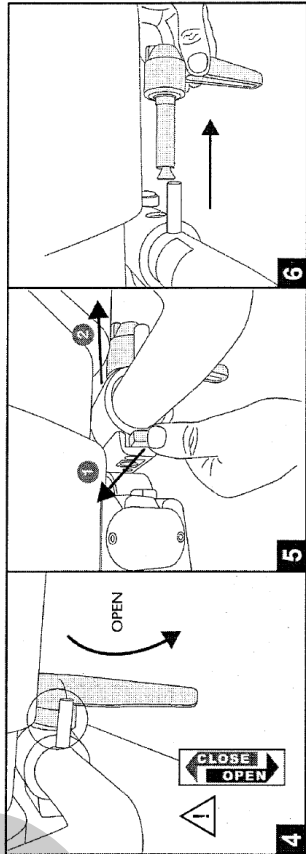
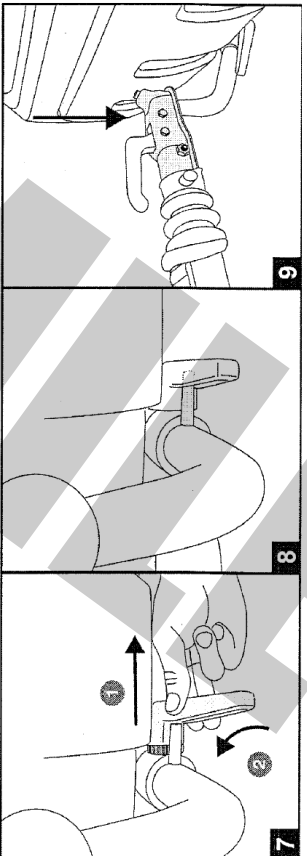
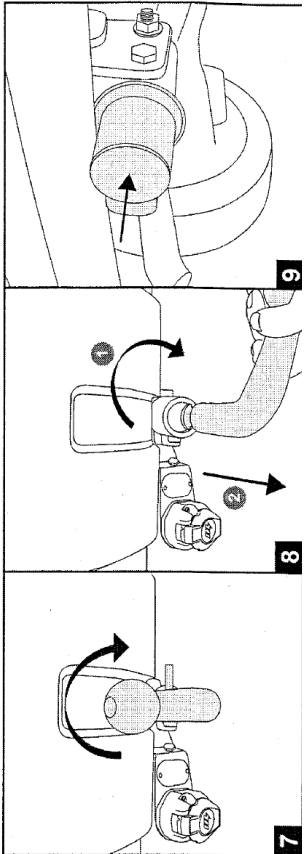
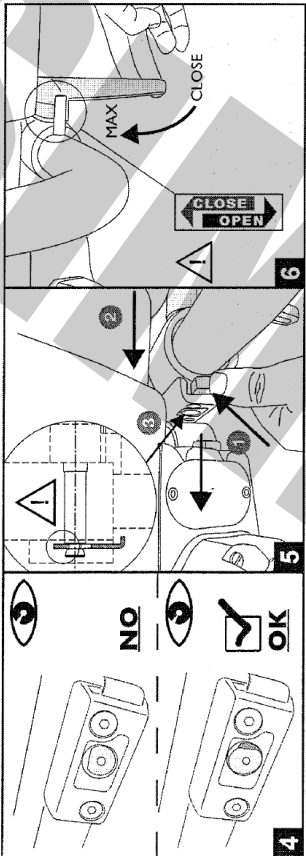
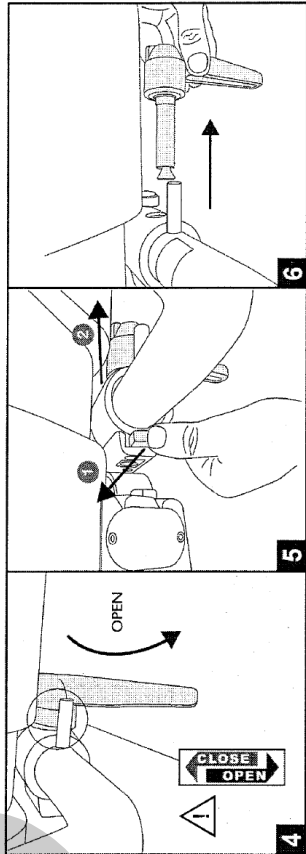
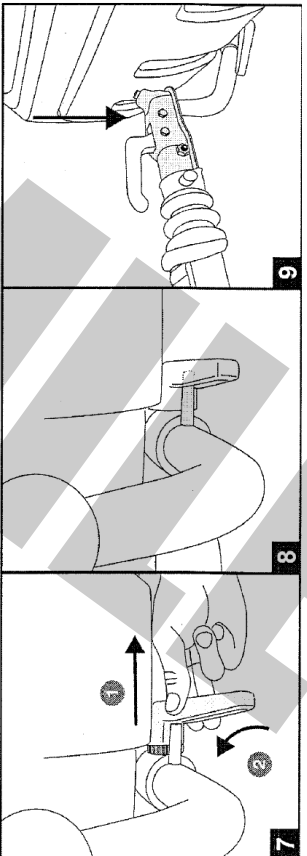
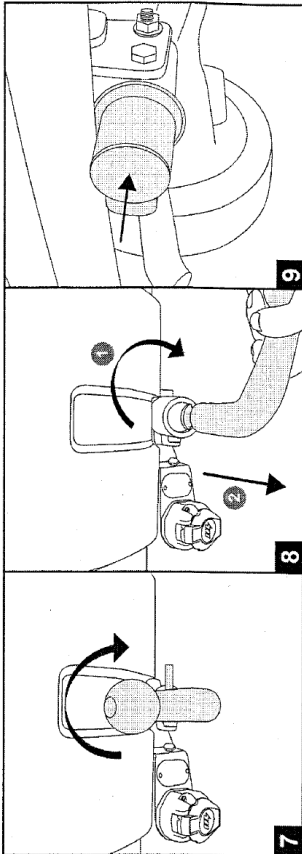
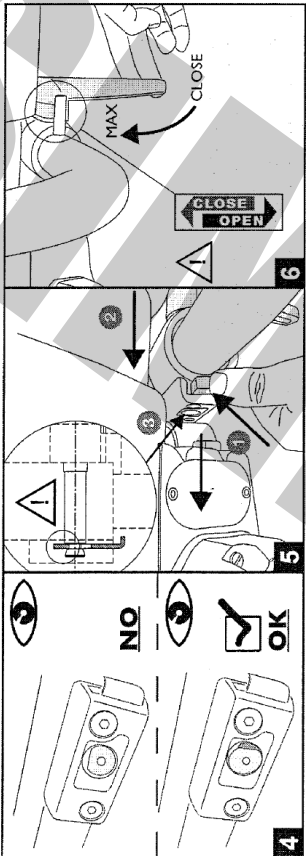
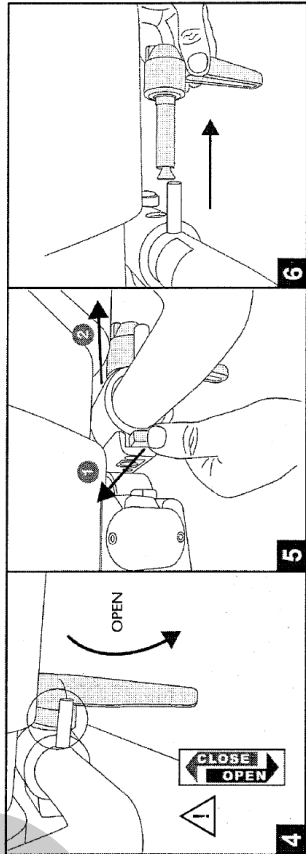
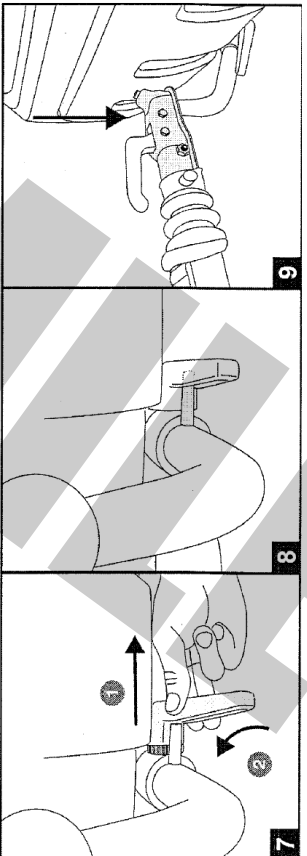
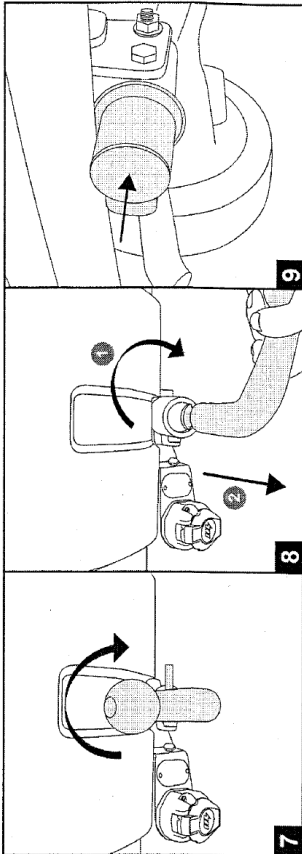
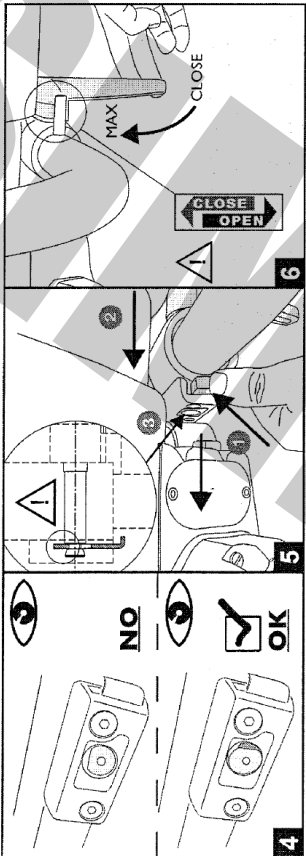
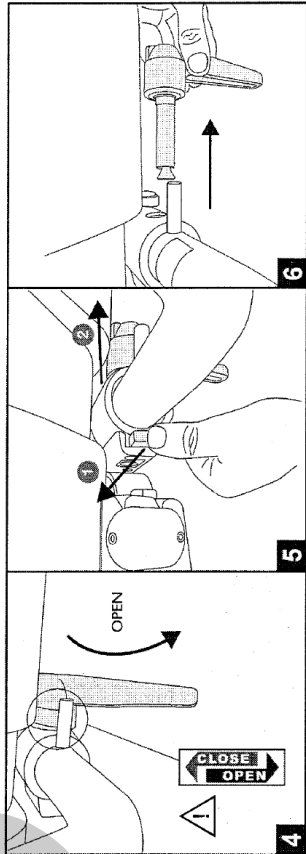
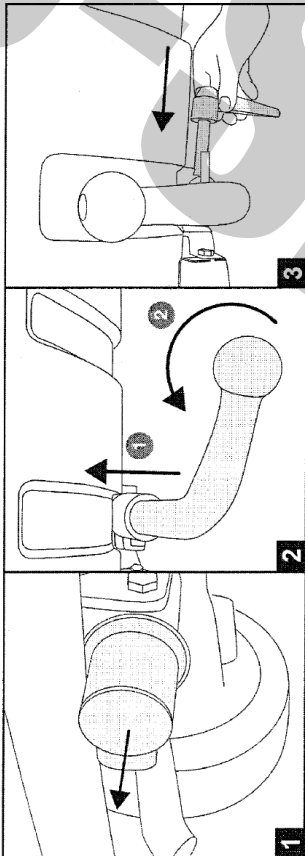
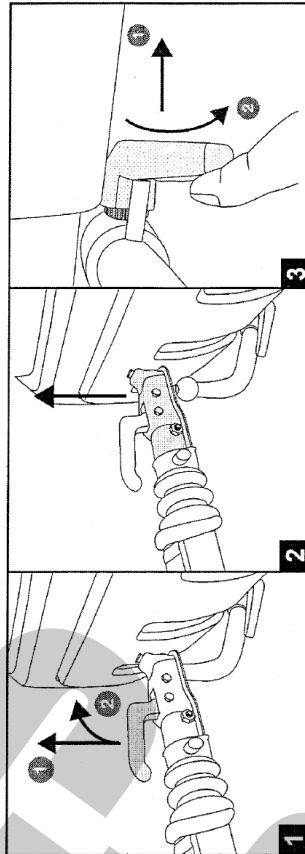

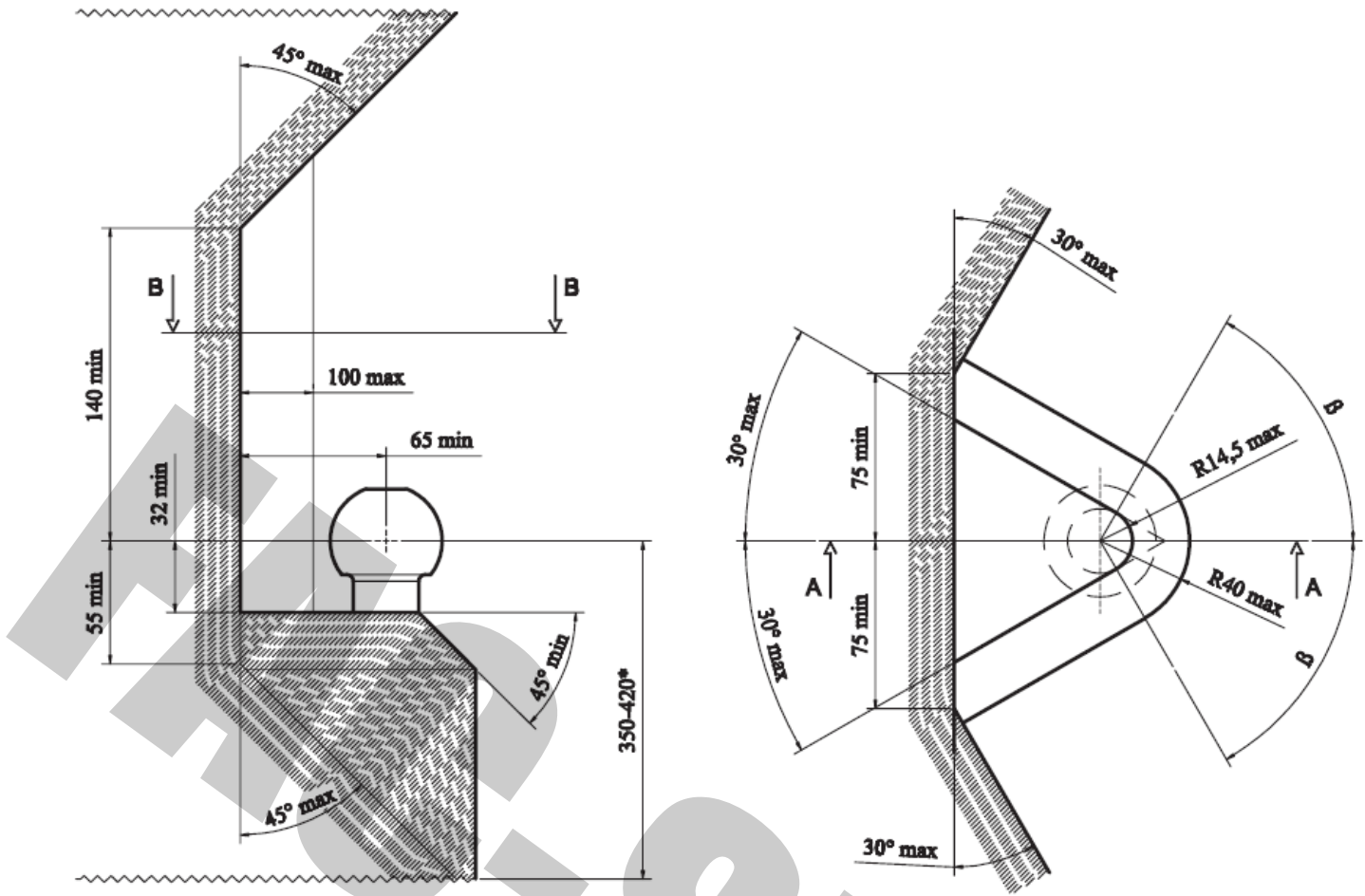

I	D
<p>Deve essere garantito lo spazio libero secondo l'allegato VII, figura 30 della direttiva 94/20/CE.</p> <p>*per il peso complessivo ammesso del veicolo</p>	<p>Der Freiraum nach Anhang VII, Abbildung 30 der Richtlinie 94/20/EG ist zu gewährleisten.</p> <p>* bei zulässigem Gesamtgewicht des Fahrzeuges</p>
GB	RU
<p>The clearance specified in appendix VII, diagram 30 of guideline 94/20/EC must be guaranteed.</p> <p>*at gross vehicle weight rating</p>	<p>Должно быть гарантировано свободное пространство в соответствии с Приложением VII, рисунок 30 Директива 94/20/ЕС для массы транспортного средства</p>
F	UA
<p>L'espace libre doit être garanti conformément à l'annexe VII, illustration 30 de la directive 94/20/CE.</p> <p>*pour poids total en charge autorisé du véhicule</p>	<p>Повинен бути гарантоване вільний простір відповідно до Додатку VII, малюнок 30 Директива 94/20/ЕС для маси транспортного засобу</p>



ahkupplungen.de