

FITTING INSTRUCTION

Clamp mark in acc. with		Cables joining
ISO	PN	
1	L	Left directional lights
2	+	Rear fog lights
3	31	Ground
4	R	Right directional lights
5	58R	Right side parking lights
6	54	Stoptlights
7	58L	Left side parking lights

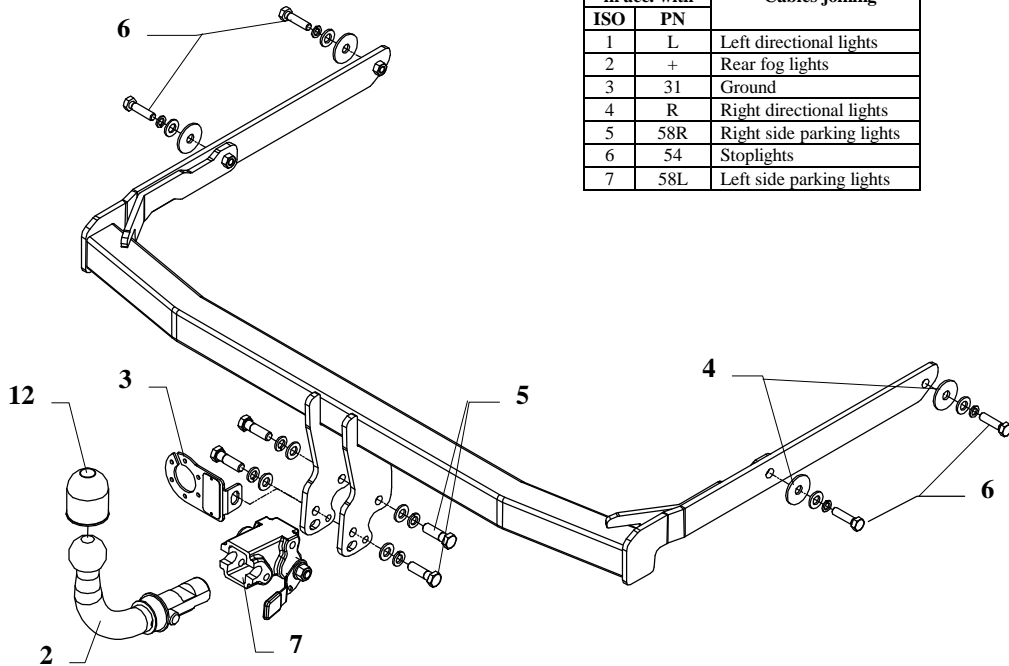

This towbar is designed to assembly in following car:
FORD FUSION produced since 2002 , catalogue no. **C43A** and is prepared to tow trailers max total weight **900kg** and max vertical load **50kg**.

From manufacturer

Thank you for buying our product. Their reliability has been confirmed in many tests. Reliability of towbar depends also on correct assembly and right operation. For this reasons we kindly ask to read carefully this instruction and apply to hints.

The towbar should be install in points described by a car producer..

Fitting instructions

1. Disassemble the bumper.
2. Slip main part of the towbar (pos. 1) to chassis members and fix it with bolts M10x40mm (pos. 6) from accessories (use flat washers – pos. 4).
3. Assemble the bumper.
4. Fix body of the automat (pos. 7) and the socket plate (pos. 3) using bolts M12x25mm (pos. 5) from accessories. Place tow-ball (pos. 2) according to supplied instruction.
5. Fix all bolts according to the torque shown in the table.
6. Connect electric wires according to the instruction of the car. (Recommend to make at authorized service station)
7. Supplement the paint coating damaged during assembly.

Torque settings for nuts and bolts (8,8):

M 8	25 Nm	M 10	55 Nm
M 12	85 Nm	M 14	135 Nm









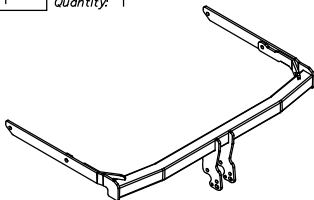

NOTE

After install the towbar you should get adequate note in registration book (at authorised service station).The car should be equipped with:

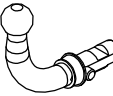
- Indicators
- Tow mirrors

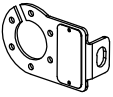
After 1000km check all bolts. The ball of towbar must be always kept clear and conserve with a grease.

Towbar accessories:

Pos. 1 Name: Main bar Quantity: 1 	Pos. 4 Name: Washer Quantity: 4 Dim.: $\varnothing 42 \times \varnothing 12 \times 3 \text{ mm}$ 	Pos. 9 Name: Plain washer Quantity: 4 Dim.: $\varnothing 10,5 \text{ mm}$ 
	Pos. 5 Name: Bolt 8,8 B Quantity: 4 Dim.: M12x25mm 	Pos. 10 Name: Spring washer Quantity: 4 Dim.: $\varnothing 12,2 \text{ mm}$ 
Pos. 2 Name: Tow ball Quantity: 1 	Pos. 6 Name: Bolt 8,8 B Quantity: 4 Dim.: M10x40mm 	Pos. 11 Name: Spring washer Quantity: 4 Dim.: $\varnothing 10,2 \text{ mm}$ 
Pos. 3 Name: Socket plate Quantity: 1 	Pos. 7 Name: Body of the automat Quantity: 1 	Pos. 12 Name: Ball cover Quantity: 1 
	Pos. 8 Name: Plain washer Quantity: 4 Dim.: $\varnothing 13 \text{ mm}$ 	Pos. 13 Name: Body plug Quantity: 1 



PPUH AUTO-HAK S.J.

Produkcja Haków Holowniczych
Henryk & Zbigniew Nejman
76-200 SŁUPSK ul. Słoneczna 16K
tel/fax (059) 8-414-414; 8-414-413
E-mail: office@autohak.com.pl
www. autohak.com.pl

Towing hitch (without electrical set)

Class: **A50-X** Cat. no. **C43A**

Designed for:

Manufacturer: **FORD**

Model: **FUSION**

produced since 2002

Technical data:

D-value: 5,70 kN

maximum trailer weight: **900 kg**

maximum vertical cup load: **50 kg**

Approval number acc. to regulations EKG/ONZ 55.01: E20-55R-01 0977

Foreword

This towbar is designed according to rules of safety traffic regulations. The towing hitch is a safety component and must be installed only by qualified personnel. Any alteration or conversion to the towinh hitch is prohibited and would lead to cancellation of design certification. Remove insulating compound and underseal from vehicle (if present) in the area of the matting surfaces of the towing hitch. The vehicle manufacturer's specifications regarding trailer load and max. vertical cup load are decisive for driving, and values for the towing hitch cannot be exceeded.

D-value formula:

$$\frac{\text{Max trailer weight [kg]} \times \text{Max vehicle weight [kg]}}{\text{Max trailer weight [kg]} + \text{Max vehicle weight [kg]}} \times \frac{9,81}{1000} = D \text{ [kN]}$$



ahkupplungen.de