

FITTING INSTRUCTION

Clamp mark in acc. with		Cables joining
ISO	PN	
1	L	Left directional lights
2	+	Rear fog lights
3	31	Ground
4	R	Right directional lights
5	58R	Right side parking lights
6	54	Stoplights
7	58L	Left side parking lights

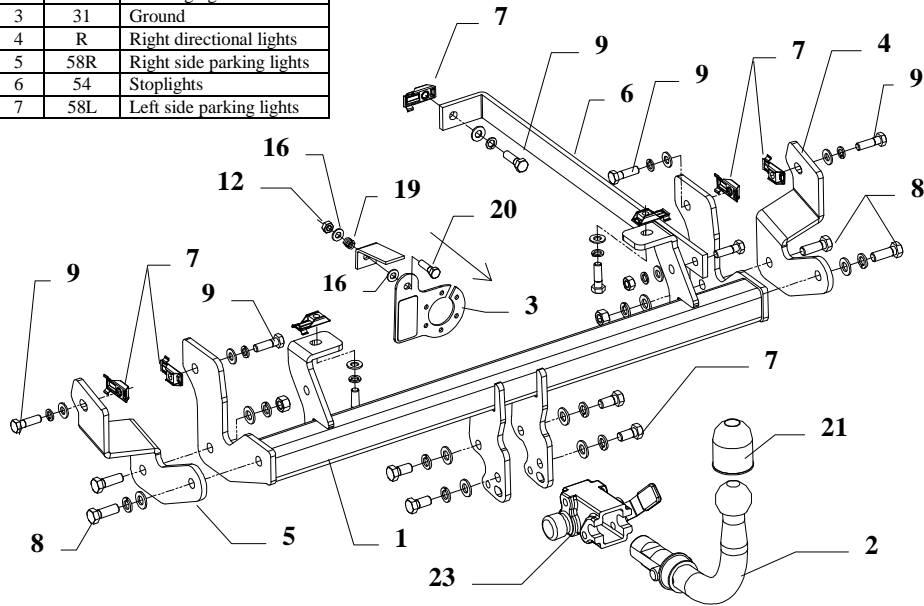

This towbar is designed to assembly in following cars: **Peugeot 807, Fiat Ulysse, Citroen C8, Lancia Z** (all 5 doors and VAN) produced since 2002 cat. no. **F26A** and is prepared to tow trailers max total weight **1850 kg** and max vertical load **76 kg**.

From manufacturer

Thank you for buying our product. Their reliability has been confirmed in many tests. Reliability of towbar depends also on correct assembly and right operation. For this reasons we kindly ask to read carefully this instruction and apply to hints.

The towbar should be install in points described by a car producer.

The instruction of the assembly

1. Disassemble the rear bumper .
2. Mounting points are original points described by a car producer. This places are covered by sticker, take them out.
3. To uncovered holes put special nuts „Caget nut” (pos.7).

4. Put mian bar of the towbar in this way, so towbar’s holes agree with caget nut, fix by M10x35mm bolts (pos. 9) as shown on the drawing (loosely).
5. Fix side brackets pos. 4, 5 and flat bar pos. 6 .
6. Cut the bumper according to the fig. 2 and then reassemble it.

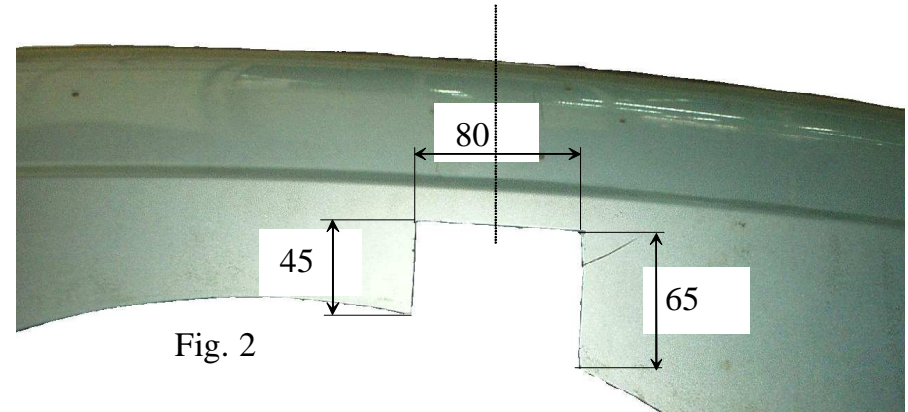

Fig. 2

7. Fix body of the automat (pos. 23) using bolts M12x25mm (pos. 7) from accessories. Place tow-ball (pos. 2) according to supplied instruction. Fix tow-ball (pos. 2) using bolts M12x75mm (pos. 7) from accessories.
8. Fix the socket plate (pos. 3) as shown on the drawing.
9. Tighten all bolts according to the torque shown in the table.
10. Connect electric wires of 7-poles socket according to the instruction of the car. (Recommend to make at authorized service station)
11. Complete paint layer damaged during installation.

Torque settings for nuts and bolts (8,8):

M6 - 11 Nm	M8 - 25 Nm	M10 - 50 Nm
M12 - 87 Nm	M14 - 138 Nm	M16 - 210 Nm











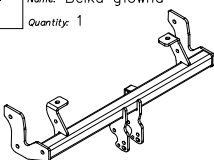
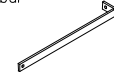



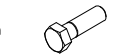

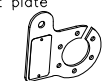
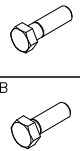

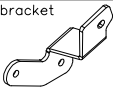
NOTE

After install the towbar you should get adequate note in registration book (at authorised service station).The car should be equipped with:

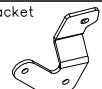
- Indicators
- Tow mirrors

After 1000km of exploitation check all bolts and nuts. The ball of towbar must be always kept clear and conserve with a grease.

Towbar accessories:

Pos. 1 Name: Belka główna Quantity: 1	Pos. 6 Name: Flat bar Quantity: 1	Pos. 12 Name: Nut 8 B Quantity: 1 Dim.: M8	Pos. 18 Name: Spring washer Quantity: 8 Dim.: Ø 10,2 mm
			
Pos. 2 Name: Część kulista Quantity: 1	Pos. 7 Name: Bolt 8,8 B Quantity: 2 Dim.: M12x75mm	Pos. 13 Name: Capet nut Quantity: 7 Dim.: M10	Pos. 19 Name: Spring Quantity: 1
			
Pos. 3 Name: Socket plate Quantity: 1	Pos. 8 Name: Bolt 8,8 B Quantity: 4 Dim.: M12x35mm	Pos. 14 Name: Plain washer Quantity: 6 Dim.: Ø 13 mm	Pos. 20 Name: Bolt 8,8 B Quantity: 1 Dim.: M8x30mm
			
Pos. 4 Name: Right bracket Quantity: 1	Pos. 9 Name: Bolt 8,8 B Quantity: 8 Dim.: M10x35mm	Pos. 15 Name: Plain washer Quantity: 8 Dim.: Ø 10,5 mm	Pos. 21 Name: Ball cover Quantity: 1
			
Pos. 5 Name: Left bracket Quantity: 1	Pos. 10 Name: Nut 8 B Quantity: 4 Dim.: M12	Pos. 16 Name: Plain washer Quantity: 2 Dim.: Ø 8,5 mm	Pos. 22 Name: Body plug Quantity: 1
			
	Pos. 11 Name: Nut 8 B Quantity: 1 Dim.: M10	Pos. 17 Name: Spring washer Quantity: 6 Dim.: Ø 12,2 mm	Pos. 23 Name: Body of the automat Quantity: 1
			



PPUH AUTO-HAK S.J.

Produkcja Zaczepów Kulowych
Henryk & Zbigniew Nejman
76-200 SŁUPSK ul. Słoneczna 16K
tel/fax (059) 8-414-414; 8-414-413
E-mail: office@autohak.com.pl
www.autohak.com.pl

Towing hitch (without electrical set)

Class: **A50-X** Cat. no. **F26A**

Designed for:

Peugeot 807 – 5 doors, VAN

Fiat Ulysse – 5 doors, VAN,

Citroen C8 – 5 doors, VAN,

Lancia Z – 5 doors, VAN

produced since 2002

Technical data:

D-value: 10,45 kN

maximum trailer weight: **1850 kg**

maximum vertical cup load: **76 kg**

Approval number according to Directive 94/20/EC: **e20*94/20*0800*00**

Foreword

This towbar is designed according to rules of safety traffic regulations. The towing hitch is a safety component and must be installed only by qualified personnel. Any alteration or conversion to the towing hitch is prohibited and would lead to cancellation of design certification. Remove insulating compound and underseal from vehicle (if present) in the area of the matting surfaces of the towing hitch.

The vehicle manufacturer's specifications regarding trailer load and max. vertical cup load are decisive for driving, and values for the towing hitch must not be exceeded.

D-value formula:

$$\frac{\text{Max trailer weight [kg]} \times \text{Max vehicle weight [kg]}}{\text{Max trailer weight [kg]} + \text{Max vehicle weight [kg]}} \times \frac{9,81}{1000} = D \text{ [kN]}$$



ahkupplungen.de