

## FITTING INSTRUCTION

Clamp mark in acc. with		Cables joining
ISO	PN	
1	L	Left directional lights
2	+	Rear fog lights
3	31	Ground
4	R	Right directional lights
5	58R	Right side parking lights
6	54	Stoplights
7	58L	Left side parking lights

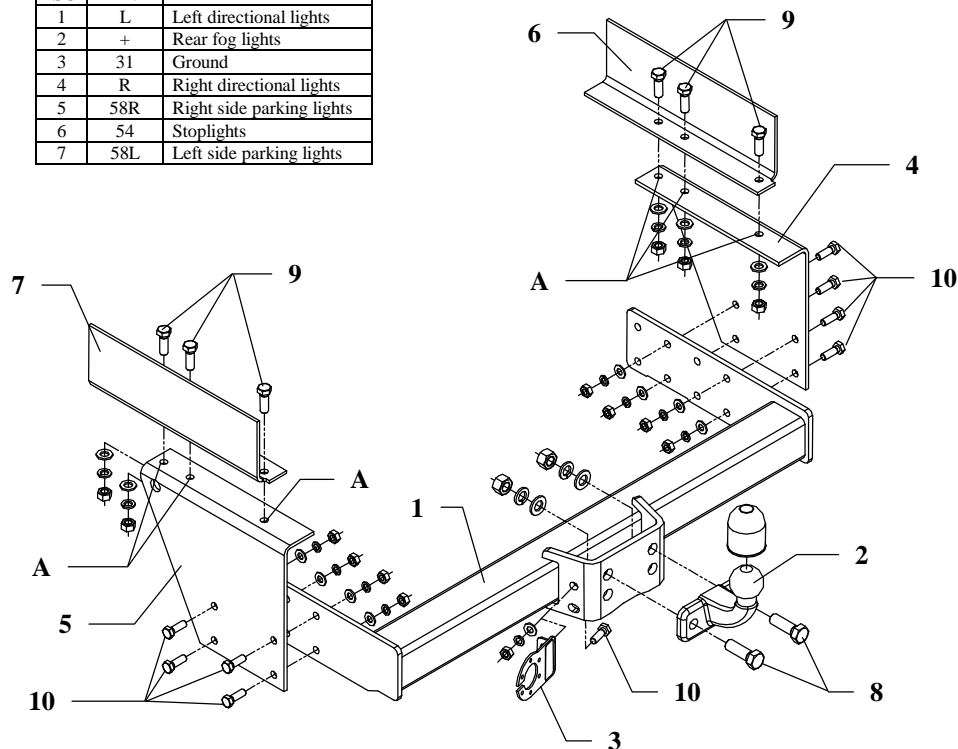

This towbar is designed to assembly in following cars:  
**FIAT IVECO DAILY metal build-up, loading platform**, produced since 1989 till 04.1999, catalogue number **R13** and is prepared to tow trailers max total weight **3000 kg** and max vertical load **100 kg**.

### *From manufacturer*

Thank you for buying our product. Their reliability has been confirmed in many tests. Reliability of towbar depends also on correct assembly and right operation. For this reasons we kindly ask to read carefully this instruction and apply to hints.

*The towbar should be installing in points described by a car producer.*

## The instruction of the assembly

- Put angle fish-plates (pos. 6 and 7) on the left and right side to the chassis frame in this way, so holes in fish-plates agree with existing holes in the frame.
- Put side brackets (pos. 4 and 5) underneath the frame and fix with fish-plates (pos. 6 and 7) through holes pos. A and through holes in the frame using bolts M12x35mm (pos. 9).
- Through original holes in the frame of chassis drill holes  $\varnothing 11\text{mm}$  in side wall of fish-plates (pos. 6 and 7). Then fix it to the frame using bolts M10x30mm (pos. 10) drilled holes did not shown on the drawing.
- Between mounted side brackets put main bar of the towbar (pos. 1) and fix using bolts M10x30mm (pos. 10).
- Fix tow-ball (pos. 2) using bolts M16x50mm (pos. 8) from accessories.  
**NOTE:** In dependence of model use agreeable holes in main bar in this way so tow-ball are in correct distance from the car.
- Fix socket plate (pos. 3) using bolt M10x30mm (pos. 10) as shown on the figure.
- Tighten all bolts according to the torque shown in the table.
- Connect electric wires of 7-poles socket according to the instruction of the car. (Recommend to make at authorized service station).
- Complete paint layer damaged during installation.

Torque settings for nuts and bolts (8,8):

<b>M6</b> - 11 Nm	<b>M8</b> - 25 Nm	<b>M10</b> - 50 Nm
<b>M12</b> - 87 Nm	<b>M14</b> - 138 Nm	<b>M16</b> - 210 Nm











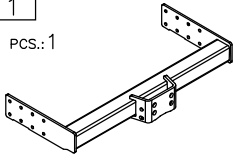









### NOTE

After install the towbar you should get adequate note in registration book (at authorised service station).The car should be equipped with:

- Indicators
- Tow mirrors

Check all bolts and nuts after **1000 km** of exploitation. The ball of towbar must be always kept clear and conserve with a grease.

## Towbar accessories:

Pos. 1 Main bar PCS.: 1 	Pos. 5 Left bracket PCS.: 1 	Pos. 10 Bolt 8,8 B M10x30mm PCS.: 15 	Pos. 15 Plain washer ø13mm PCS.: 6 
	Pos. 6 Right fish-plate PCS.: 1 	Pos. 11 Nut 8 B M16 PCS.: 2 	Pos. 16 Plain washer ø10.5mm PCS.: 15 
Pos. 2 Tow ball PCS.: 1 	Pos. 7 Lef fish-plate PCS.: 1 	Pos. 12 Nut 8 B M12 PCS.: 6 	Pos. 17 Spring washer ø16.3mm PCS.: 2 
Pos. 3 Socket plate PCS.: 1 	Pos. 8 Bolt 8,8 B M16x50mm PCS.: 2 	Pos. 13 Nut 8 B M10 PCS.: 15 	Pos. 18 Spring washer ø12.3mm PCS.: 6 
Pos. 4 Right bracket PCS.: 1 	Pos. 9 Bolt 8,8 B M12x35mm PCS.: 6 	Pos. 14 Plain washer ø17mm PCS.: 2 	Pos. 19 Spring washer ø10,2mm PCS.: 15 
			Pos. 20 Ball cover PCS.: 1 



**PPUH AUTO-HAK S.J.**

Produkcja Zaczepów Kulowych  
Henryk & Zbigniew Nejman  
76-200 SŁUPSK ul. Słoneczna 16K  
tel/fax (059) 8-414-414; 8-414-413  
E-mail: [office@autohak.com.pl](mailto:office@autohak.com.pl)  
[www.autohak.com.pl](http://www.autohak.com.pl)

## Towing hitch (without electrical set)

Class: **A50-X** Cat. no. **R13**

Designed for:

Manufacturer: **FIAT**

Model: **IVECO DAILY**

Type: **metal build-up, loading platform**

produced since 1989 till 04.1999

Technical data:

**D-value: 19,1 kN**

maximum trailer weight: **3000 kg**

maximum vertical cup load: **100 kg**

Approval number according to Directive 94/20/EC: **e20\*94/20\*0629\*00**

## Foreword

This towbar is designed according to rules of safety traffic regulations. The towing hitch is a safety component and can be install only by qualified personnel. Any alteration or conversion of the towing hitch is prohibited and would lead to cancellation of design certification. Remove insulating compound and underseal from vehicle (if present) in the area of the matting surfaces of the towing hitch.

The vehicle manufacturer's specifications regarding trailer load and max. vertical cup load are decisive for driving whereat values for the towing hitch cannot be exceeded.

*D-value formula:*

$$\frac{\text{Max trailer weight [kg]} \times \text{Max vehicle weight [kg]}}{\text{Max trailer weight [kg]} + \text{Max vehicle weight [kg]}} \times \frac{9,81}{1000} = D \text{ [kN]}$$



[ahkupplungen.de](http://ahkupplungen.de)