

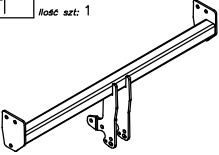

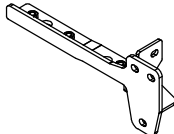







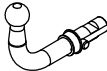





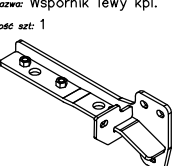

Towbar accessories:

Poz. 1 Nazwa: Belka główna Ilość szt.: 1 	Poz. 5 Nazwa: Wspornik prawy kpl. Ilość szt.: 1 	Poz. 10 Nazwa: Śruba 8,8 B Ilość szt.: 12 Wymiar: M12x35mm 	Poz. 16 Nazwa: Podkładka sprężynowa Ilość szt.: 2 Wymiar: Ø 8,2 mm 
Poz. 2 Nazwa: Część kulista Ilość szt.: 1 	Poz. 6 Nazwa: Podkładka zwykła Ilość szt.: 6 Wymiar: Ø37xØ13x3mm 	Poz. 11 Nazwa: Śruba 8,8 B Ilość szt.: 2 Wymiar: M8x35mm 	Poz. 17 Nazwa: Ostonka kuli Ilość szt.: 1 
Poz. 3 Nazwa: Płyta gniazda Ilość szt.: 1 	Poz. 7 Nazwa: Podkt. dystansowa Ilość szt.: 2 Wymiar: 48x48x10mm 	Poz. 12 Nazwa: Nakrętka 8 B Ilość szt.: 7 Wymiar: M12 	Poz. 18 Nazwa: Korpus automatu Ilość szt.: 1 
Poz. 4 Nazwa: Wspornik lewy kpl. Ilość szt.: 1 	Poz. 8 Nazwa: Śruba 8,8 B Ilość szt.: 4 Wymiar: M12x25mm 	Poz. 13 Nazwa: Podkładka zwykła Ilość szt.: 9 Wymiar: Ø 13 mm 	Poz. 19 Nazwa: Nakładka Ilość szt.: 1 
	Poz. 9 Nazwa: Śruba 8,8 B Ilość szt.: 1 Wymiar: M12x60mm 	Poz. 14 Nazwa: Podkładka zwykła Ilość szt.: 2 Wymiar: Ø 8,5 mm 	Poz. 20 Nazwa: Zasłepka korpusu Ilość szt.: 1 
		Poz. 15 Nazwa: Podkładka sprężynowa Ilość szt.: 17 Wymiar: Ø 12,2 mm 	

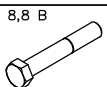

PPUH AUTO-HAK S.J.

Produkcja Haków Holowniczych
Henryk & Zbigniew Nejman
76-200 SŁUPSK ul. Słoneczna 16K
tel/fax (059) 8-414-414; 8-414-413
E-mail: office@autohak.com.pl
www. autohak.com.pl

Towing hitch (without electrical set)

Class: **A50-X** Cat. no. **Y31A**

Designed for:

Manufacturer: **HONDA**

Model: **FR-V**

produced since 2005

Technical data:

D-value: 8,70 kN

maximum trailer weight: **1500 kg**

maximum vertical cup load: **90 kg**

Approval number acc. to regulations EKG/ONZ 55.01: **E20-55R-01 1795**

Foreword

This towbar is designed according to rules of safety traffic regulations. The towing hitch is a safety component and can be install only by qualified personnel. Any alteration or conversion of the towing hitch is prohibited and would lead to cancellation of design certification. Remove insulating compound and underseal from vehicle (if present) in the area of the matting surfaces of the towing hitch.

The vehicle manufacturer's specifications regarding trailer load and max. vertical cup load are decisive for driving, and values for the towing hitch cannot be exceeded.

D-value formula:

$$\frac{\text{Max trailer weight [kg]} \times \text{Max vehicle weight [kg]}}{\text{Max trailer weight [kg]} + \text{Max vehicle weight [kg]}} \times \frac{9,81}{1000} = D \text{ [kN]}$$

FITTING INSTRUCTION

Clamp mark in acc. with		Cables joining
ISO	PN	
1	L	Left directional lights
2	+	Rear fog lights
3	31	Ground
4	R	Right directional lights
5	58R	Right side parking lights
6	54	Stoplights
7	58L	Left side parking lights

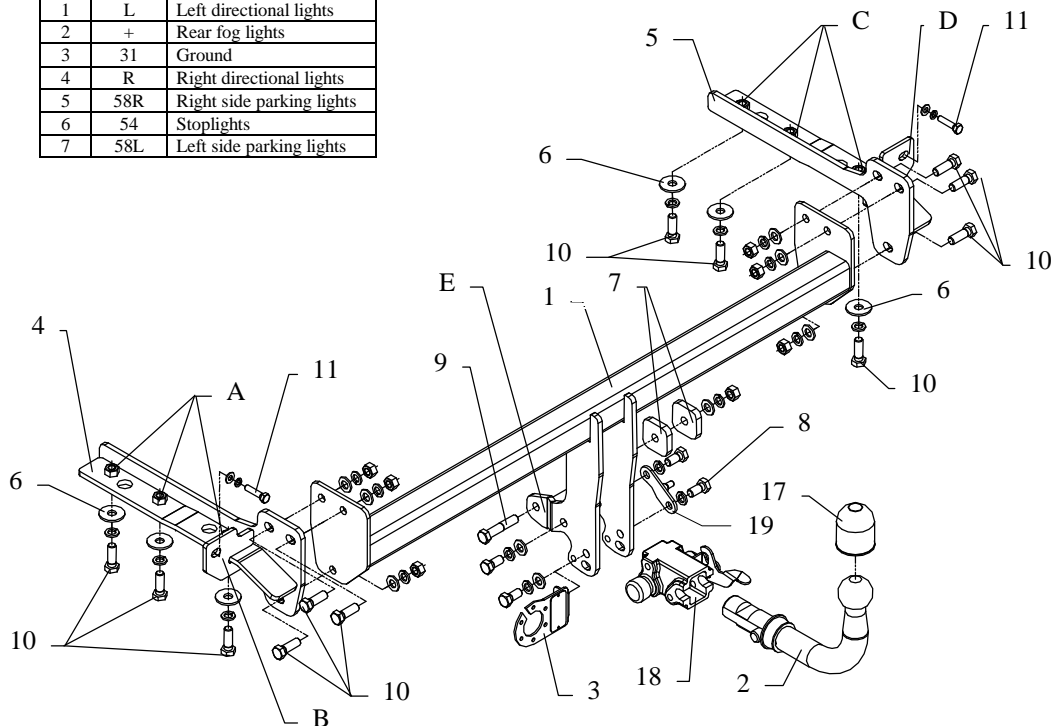

This towbar is designed to assembly in following cars:

HONDA FR-V produced since 2005, catalogue no. **Y31A** and is prepared to tow trailers max total weight **1500 kg** and max vertical load **90 kg**.

From manufacturer

Thank you for buying our product. Their reliability has been confirmed in many tests. Reliability of towbar depends also on correct assembly and correct exploitation. For this reasons we kindly ask to read carefully this instruction and apply to hints.

The towbar should be install in points described by a car producer.

The instruction of the assembly

- Disassemble the bumper
 - remove two bolts in left and right wheel housing
 - remove two plastic bolts from below and two from above the bumper
- Loosen plastic covers on the left and right side of the bumper.
- Remove bumper's filling (not used any more).
- Inside the bumper unscrew two inmost bolts.
- Fix element (pos. 4) through holes (pos. A) using bolts M12x35mm (pos. 10) – use washers (pos. 6) and through hole (pos. B) using bolt M8x35mm (pos. 11), see figure 1.
- Fix element (pos. 5) through holes (pos. C) using bolts M12x35mm (pos. 10) – use washers (pos. 6) and through hole (pos. D) using bolt M8x35mm (pos. 11), see figure 1.
- Between installed elements (pos. 4 and 5) put main bar of the towbar (pos. 1) and fix it using bolts M12x35mm (pos. 10).
- Fix main bar of the towbar with original tow eye through hole (pos. E) using bolt M12x60mm (pos. 9), use square distance sleeves (pos. 7).

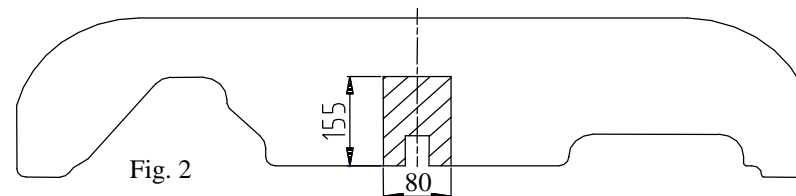

- Reassemble the bumper after cut out his fragment – see figure 2.
- Fix body of the automat (pos. 18) and the socket plate (pos. 3) using bolts M12x25mm (pos. 8) from accessories. Place tow-ball (pos. 2) according to supplied instruction.
- Tighten all bolts according to the torque shown in the table.
- Connect electric wires of 7-poles socket according to the instruction of the car. (Recommend to make at authorized service station)
- Complete paint layer damaged during installation.

Torque settings for nuts and bolts (8,8):

M 8 - 25 Nm

M 10 - 55 Nm

M 12 - 85 Nm

M 14 - 135 Nm

NOTE

After install the towbar you should get adequate note in registration book (at authorised service station).The car should be equipped with:

- Indicators
- Tow mirrors

After 1000km check all bolts and nuts. The ball of towbar must be always kept clear and conserve with a grease.



ahkupplungen.de